



## Instructions for use



synea<sup>FUSION</sup>

**Straight handpiece HG-43 A**

**Contra-angle handpieces with light  
WG-99 LT, WG-56 LT, WG-66 LT**

**Contra-angle handpieces without light  
WG-99 A, WG-56 A, WG-66 A**

## Contents

---

<b>W&amp;H Symbols</b> .....	3 – 4
<b>1. Introduction</b> .....	5 – 7
<b>2. Safety notes</b> .....	8 – 9
<b>3. Product description</b> .....	10 – 11
<b>4. Operation</b> .....	12 – 17
Assembly/Removal, To change rotary instrument, Test run	
<b>5. Hygienic maintenance</b> .....	18 – 29
General, Pre-sterilization, Manual cleaning, Manual Disinfection, Mechanical cleaning and disinfection, Oil service, Sterilization	
<b>6. W&amp;H Accessories</b> .....	30
<b>7. Technical data</b> .....	31 – 33
<b>8. Recycling and disposal</b> .....	34
<b>Letter of indemnity</b> .....	35
<b>Authorized W&amp;H service partner</b> .....	37

## W&H Symbols

---

Symbols in the Instructions for use



**WARNING!**  
(Risk of injury)



**ATTENTION!**  
(to prevent  
damage occurring)



General explanations,  
without risk to persons  
or objects





Do not dispose of with  
domestic waste

## W&H Symbols

---

### Symbols on the instrument

 CE 0297  
from the manufacturer

 Thermo washer disinfectable

 135°C  
Sterilizable up to the  
stated temperature

 Date of manufacture

 Data Matrix Code for  
product identification, e.g.  
in hygiene / maintenance  
process

 UL Component Recognition  
Mark indicates compliance  
with Canadian and  
U.S. requirement

**REF** Catalogue number

**SN** Serial number

## **1. Introduction**

---

Customer satisfaction has absolute priority in the W&H quality policy. This W&H product has been developed, manufactured and subjected to final inspection according to legal regulations, quality norms and industry standards.

### **For your safety and the safety of your patients**

Prior to initial use please read the instructions for use. These explain how to use your W&H product and guarantee a smooth and efficient operation.

### **Intended use**

The dental straight/contra-angle handpiece is intended for the following applications: Removal of decayed materials, cavities and crown cement, removal of fillings, finishing and polishing of tooth and restoration surfaces.

Misuse may damage the straight/contra-angle handpiece and hence cause risks and hazards for patients, users and third parties.

## Qualifications of the user

We have based our development and design of the dental straight and contra-angle handpiece on the »dentists, dental hygienists, dental employees (prophylaxis) and dental assistants« target group.



### Production according to EU directive

The straight/contra-angle handpiece is a medical product according to the EU-directive 93/42/EEC.



### Responsibility of the manufacturer

The manufacturer can only accept responsibility for the safety, reliability and performance of the straight/ contra-angle handpiece when it is used in compliance with the following directions:

- > The straight/contra-angle handpiece must be used in accordance with these Instructions for use.
- > The straight/contra-angle handpiece has no components that can be repaired by the user. Assembly, modifications or repairs must only be undertaken by an authorized W&H service partner (see page 37).

### **Skilled application**

The straight/contra-angle handpiece is intended only for skilled application in dentistry according to its purpose of use in compliance with the valid health and safety at work regulations, the valid accident prevention regulations as well as in compliance with these Instructions for Use. The handpiece / contra-angle should be prepared for use and maintained by staff who have been trained in procedures for infection control, personal safety and patient safety. Improper use, (e.g. through poor hygienic maintenance), non-compliance with our instructions or the use of accessories and spare parts which are not approved by W&H, invalidates all claims under warranty and any other claims.

### **Service**

In case of service or repair contact an authorized W&H service partner (see page 37).

Service and maintenance work must only be carried out by an authorized W&H service partner.

## 2. Safety notes

---



- > Always ensure the correct operating conditions and cooling function.
- > Always ensure that sufficient and adequate cooling is delivered and ensure adequate suction. In case of coolant supply failure, the straight/contra-angle handpiece must be stopped immediately.



- > Use only non-contaminated, filtered, oil-free and dry compressed air to operate the straight/ contra-angle handpiece.
- > Check the straight/contra-angle handpiece for damage and loose parts each time before using [e.g. press-button on the contra-angle handpiece].
- > Do not operate the straight/contra-angle handpiece if it is damaged.
- > The operation of the contra-angle with light is permitted only on dental units which correspond to the standards IEC 60601-1 (EN 60601-1) and IEC 60601-1-2 (EN 60601-1-2).  
The power supply unit for the dental unit must satisfy the following requirements to be guaranteed by the system assembler:
  - > The compliance with the leakage currents of the application section must be guaranteed by the system assembler.
  - > The secondary voltage must be non-earthed.



- > The secondary circuits must be protected against short-circuiting and overloading.
- > Perform a test run prior to each treatment.
- > Avoid contact between the instrument head and soft tissue (danger of burning due to the press-button heating up).
- > Run the rinse function for the dental unit once per day.

### **Hygiene and maintenance prior to initial use**

The straight/contra-angle handpiece is in a clean condition and sealed in PE-film when delivered. Lubricate the contra-angle handpiece prior to initial use. Sterilize straight/contra-angle handpiece and nozzle cleaner as well as the limit stop and threaded pin of the straight handpiece.

- > Oil service      page 24
- > Sterilization    page 28

### 3. Product description

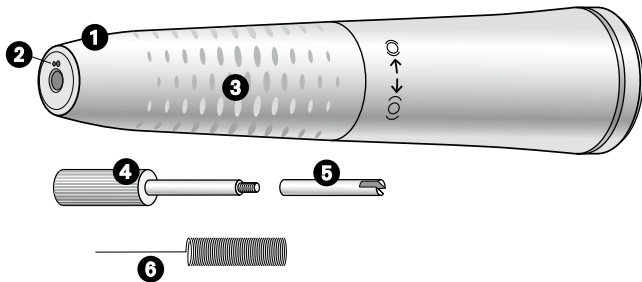

#### **Straight handpiece**

- 1** Handpiece sleeve with twist chuck
- 2** Spray nozzles
- 3** Grip profile
- 4** Threaded pin
- 5** Bur limit stop
- 6** Nozzle cleaner

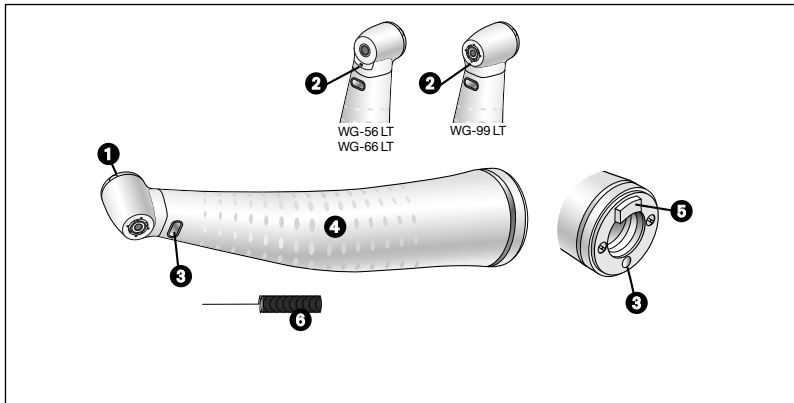

## Contra-angles

- ❶ Press-button
- ❷ Spray nozzle
- ❸ Compact optic outlet\*
- ❹ Grip profile
- ❺ Nose\*
- ❻ Nozzle cleaner

\* only contra-angles with light

## 4. Operation – Assembly / Removal

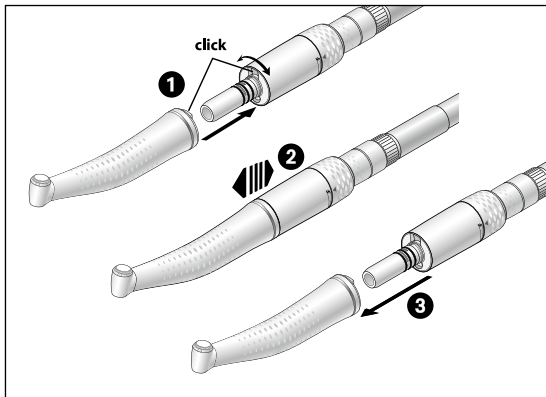

**Do not assemble/remove during the operation!**

- 1** Push the straight/contra-angle handpiece onto the motor and turn it until it engages audibly.
- 2** Check the connection to the motor is secure.
- 3** Remove the straight/contra-angle handpiece from the motor by pulling in an axial direction.



### **Rotary instruments**

- > Use only rotary instruments which are in perfect condition and which have shanks that meet the requirements of the DIN EN ISO 1797-1 standard. Follow the operating instructions of the manufacturer.
- > Insert rotary instruments only when the straight/contra-angle handpiece is stationary.
- > Do not interfere with the running or slowing down of rotary instruments.
- > Do not activate the rotary chuck of the handpiece or press-button of the contra-angle during operation or slowing down. This leads to detachment of the rotary instruments, damage to the rotary chuck (handpiece), and/or makes the press-button hot (contra-angle) (risk of injury).

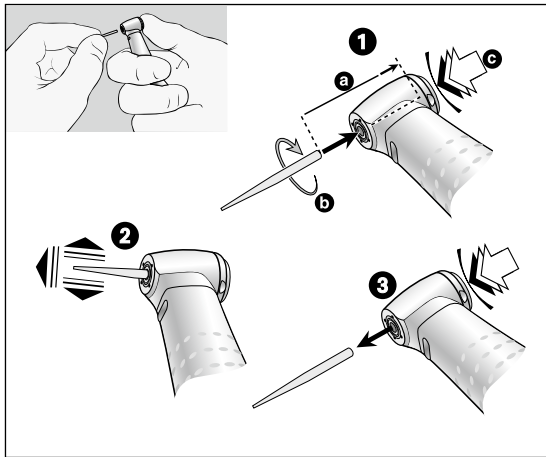

## Contra-angles To change rotary instrument

- 1 Rotary instrument shank  $\varnothing 1,6\text{ mm}$ :**  
Insert rotary instrument.  
Press the button firmly (c) and at the same time insert the rotary instrument until it reaches the limit stop (a).  
Rotary instrument shank  $\varnothing 2,35\text{ mm}$ :  
Press the button (c) and at the same time insert the rotary instrument and turn it until it snaps into place (b).
- 2 Check secure location by applying slight axial tension.**
- 3 Remove the rotary instrument by pushing the press-button.**

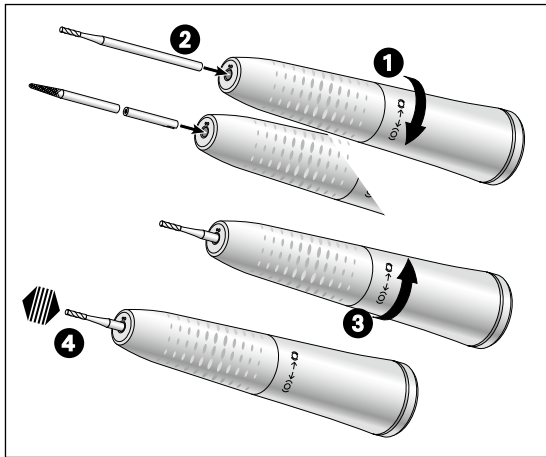

## Straight handpieces

### Inserting the rotary instrument

- 1** Rotate the handpiece sheath in an anticlockwise [ O ] direction [ opening ] until it clicks.
- 2** *Handpiece bur:*  
Insert the rotary instrument up to the limit stop.  
*Contra-angle handpiece bur:*  
Insert the bur limit stop and then insert the rotary instrument up to the limit stop. The bur limit stop compensates for the difference in length.
- 3** Rotate the handpiece sheath in a clockwise [ O ] direction [ closing ] until it clicks.
- 4** Check that the rotary instrument is held securely by pulling on it in an axial direction.

## Test run



Do not hold the straight/contra-angle handpiece at eye level!

- > Insert rotary instrument.
- > Start the straight/contra-angle handpiece.
- > If you observe problems (e.g. vibrations, unusual noise, overheating, coolant supply failure or leakage) **stop the handpiece/contra-angle immediately** and contact an authorized W&H service partner organization (see page 37).



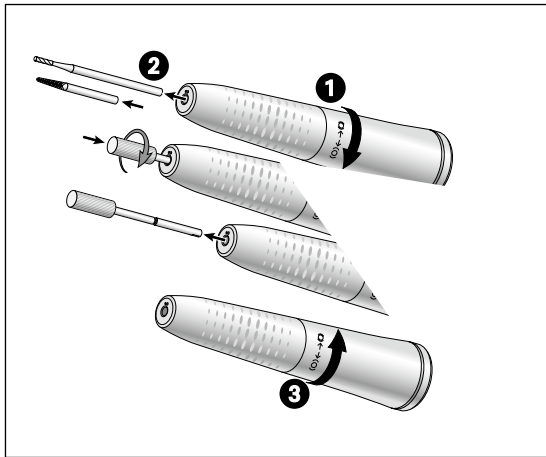

## Straight handpiece Removing the rotary instrument

- 1 Rotate the handpiece sheath in an anticlockwise [ 0 ] direction [ opening ] until it clicks.
- 2 *Handpiece bur:*  
Remove the rotary instrument.  
*Contra-angle handpiece bur:*  
Screw the threaded pin clockwise into the bur limit stop and pull the latter out.
- 3 Rotate the handpiece sheath in a clockwise [ 0 ] direction [ closing ] until it clicks.

## 5. Hygiene and maintenance

---



Follow your country-specific directives, standards and guidelines for cleaning, disinfection and sterilization.

> You can process the straight/contra-angle handpiece manually or mechanically.



> Wear protective clothing

> Remove the rotary instrument.

> Remove the straight/contra-angle handpiece from the motor.

> Clean and disinfect the straight/contra-angle handpiece **immediately after every treatment**, to flush out any liquid (e. g. blood, saliva etc.) and to prevent settling on the internal parts.

> Sterilize the handpiece/contra-angle following manual or mechanical cleaning, disinfection and lubrication.

> Sterilize the nozzle cleaner following cleaning and disinfection.

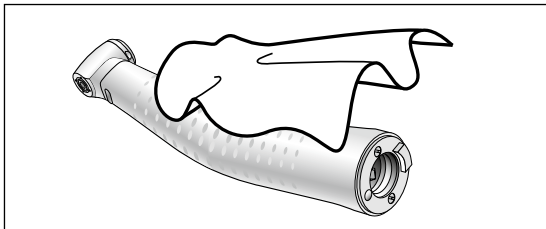

## Pre-disinfection

- > If heavily soiled:  
Clean first with disinfectant cloths.



Only use disinfectants that have no protein-fixing effects.

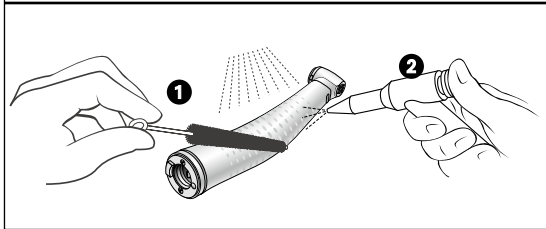

## Manual cleaning (internal and external)

- ➊ Rinse and brush off under demineralized water (< 38 °C).
- ➋ Remove any liquid residues (absorbent cloth, blow dry with compressed air).



Do not place the handpiece/contra-angle in liquid disinfectant or in an ultrasonic bath.

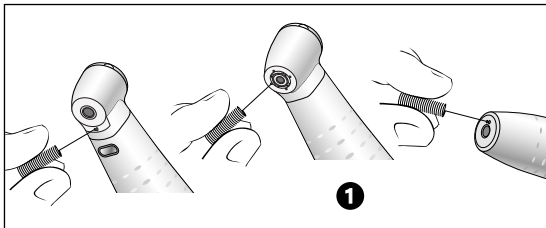

## Clean spray nozzles

- ❶ Clean spray nozzles carefully with the nozzle cleaner to remove dirt and deposits.
- > Clean and disinfect the nozzle cleaner in an ultrasonic bath/disinfection bath.

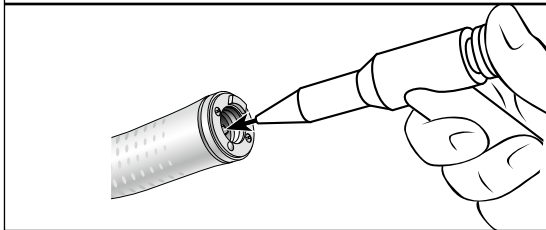

## Cleaning the coolant tube

Blow through the coolant tube with an air syringe.

- ☞ In the case of clogged spray nozzles or coolant tubes contact an authorized W&H service partner (see page 37).

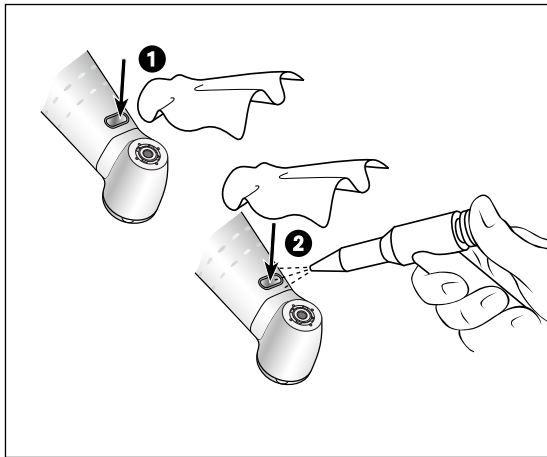

## Cleaning of the optic outlet



**Avoid scratching the optic outlet!**

- 1 Wash the optic outlet with cleaning fluid and a soft cloth.
- 2 Blow the optic outlet dry with air syringe or dry it carefully with a soft cloth.



Carry out a visual inspection after each cleaning process. Do not use the handpiece/contra-angle if the optic outlet is damaged and contact an authorized W&H service partner [see page 37].

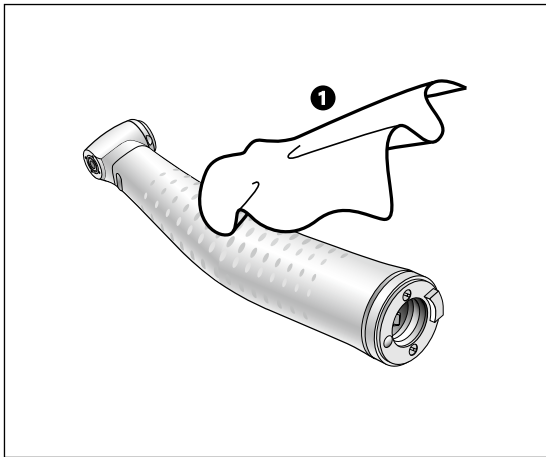

### Manual disinfection

- > Disinfection with disinfectants.
  - ① wiping disinfection is recommended.
- > Use only disinfectants which do not contain chlorine and which are certified by officially recognized institutes.
- > Note the manufacturer's specifications for the use of the disinfectants.



After manual cleaning, disinfection and lubrication you must carry out a final thermal disinfection (unwrapped) or sterilization (wrapped) in the class B or S steam sterilizer (according to EN 13060).

## Mechanical cleaning and disinfection internal and external



The straight/contra-angle handpiece can be cleaned and disinfected in a thermo washer disinfectant.



W&H recommends processing with thermo washer disinfectant.

> Note the manufacturer's specifications on equipment, cleaning agents and detergents.



> Make sure, that the straight/contra-angle handpiece is completely dry internally and externally after thermo washer disinfection. Remove any liquid residues with compressed air.

> Lubricate the dry handpiece/contra-angle immediately after thermo washer disinfection.

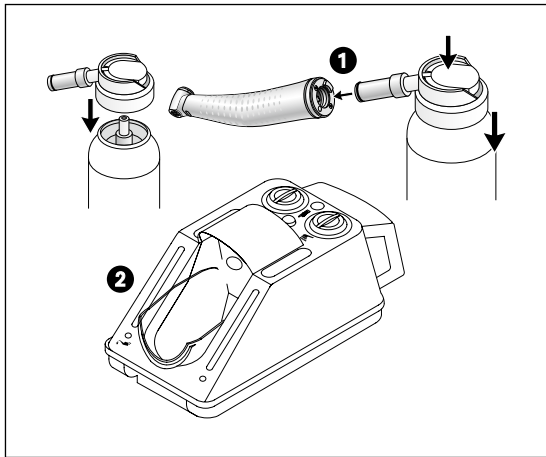

## Daily oil service

- ❶ Only with W&H Service Oil F1, MD-400
- > Follow the instructions for use of the oil spray can.

or

- ❷ Only with W&H Assistina
- > See instructions for use of Assistina.

## Recommended lubrication cycles

- > Essential after every internal cleaning
  - > Before each sterilization
- or
- > After 30 minutes of use or at least once daily



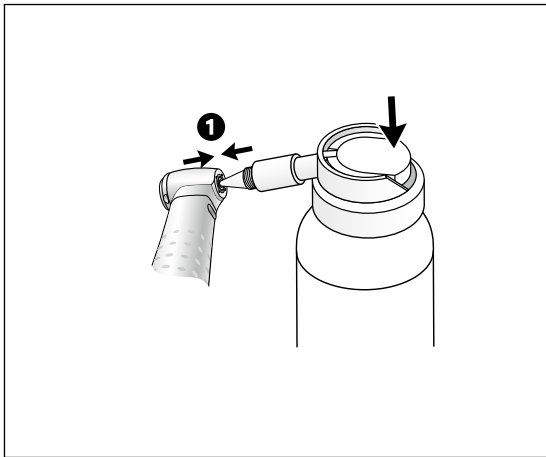

## Weekly oil service of the chuck system

- ❶ Only with W&H Service Oil F1, MD-400
  - > Fit the spray cap REF 02036100 on the spray can.
  - > Hold the contra-angle handpiece firmly.
  - > Press the tip of the spray nozzle firmly into the chuck system.
  - > Spray for approx. 1 second.

or

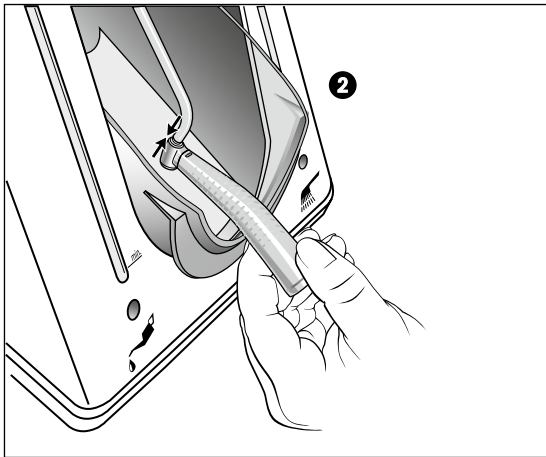

**2 Only with W&H Assistina**

- > Fit the adaptor REF 02693000 onto the maintenance attachment. Direct spray exit nozzle downwards.
- > Press the bur side of the contra-angle onto the adaptor from below.
- > Start the Assistina.
- > Press the contra-angle onto the adaptor for approx. 10 seconds.
- > Remove the contra-angle from the adaptor.
- > Close the cover of the Assistina and allow it to run for the remainder of the maintenance cycle [approx. 25 seconds].

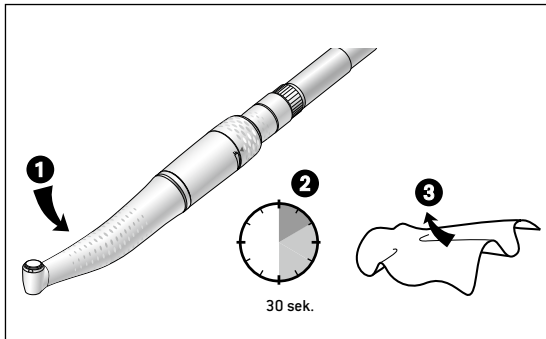

### Test run following oil service

- 1** Place the straight/contra-angle handpiece with the instrument tip/head downwards.
- 2** Start the straight/contra-angle handpiece for 30 seconds to remove excess oil.
  - > Start at the minimum speed and increase to the maximum speed within 5 to 10 seconds.
  - > Repeat the entire hygiene and maintenance process if dirt emerges.
- 3** Wipe the straight/contra-angle handpiece with gauze or a soft cloth.

## **Sterilization and storage**



W&H recommends sterilization according to EN 13060, class B

- > Note the instructions of the unit manufacturer.
- > Clean, disinfect and lubricate prior to sterilization.
- > Wrap the straight/contra-angle handpiece and the accessory in sterile goods packing according to EN 868-5.
- > Make sure, that you only remove dry sterile goods.
- > Store sterile goods dust-free and dry.



The standard ISO 7785-2/ISO 14457 stipulates a durability of at least 250 sterilization cycles. In the case of the straight/contra-angle handpiece from W&H, we recommend you to have a regular service carried out after 1000 sterilization cycles or one year.

## Approved sterilization methods



Observe your country-specific guidelines, standards and requirements.

- > Steam sterilization class B (pre and post vacuum) with sterilizers in accordance with EN 13060. Sterilization holding time a minimum of 3 minutes at 134 °C

or

- > Steam sterilization class S with sterilizers in accordance with EN 13060. The sterilizer manufacturer must give their express approval for the sterilization of handpieces/contra-angles. Sterilization holding time a minimum of 3 minutes at 134 °C

## 6. W&H Accessories

---

Use only original W&H accessories and spare parts!

**Suppliers:** W&H partners

301	W&H Assistina
02693000	Assistina adaptor for chuck system
10940021	W&H Service Oil F1, MD-400 (6 pcs)
02015101	Nozzle cleaner
02038200	Spray cap with nozzle for straight/contra-angle handpieces
02036100	Spray cap with spray nozzle for chuck system
01312500	Bur limit stop
01312600	Threaded pin (for dismantling bur limit stop)

## 7. Technical data

Straight handpiece		HG-43 A
Transmission ratio		1 : 1
Colour coding		1 blue ring
Motor coupling		ISO 3964
Instrument	acc. to EN ISO 1797-1:1995 ( $\varnothing$ mm)	2.35
Length in mm approved by W&H	(mm)	Contra-angle bur 34 * / Handpiece bur 50 *
Chucking		Contra-angle shank: with bur limit stop * / Handpiece shank:
Min. chuck length		12* / to the limit stop*
Max. motor speed	( $\text{min}^{-1}$ )	40,000
Spray flow rate	acc. to (ml/min)	> 50
Water setting range (rec. water pressure)	(bar)	0.5 – 2 (1.5) **
Chip air setting range (must be higher than the water pressure) (rec. chip air pressure)	(bar)	1.5 – 3 (2)**
Chip air consumption at 2 bar	[Nl/min]	> 1.5

\* If the rotary instrument is not inserted up to the limit stop, the minimum chucking length must be maintained. In this case, or when using longer rotary instruments than 50 mm, the user must ensure by correct selection of the operating conditions that there is no danger to the user, patients or third parties.

\*\* The chip air / water pressure must be set at the same time  
rpm =  $\text{min}^{-1}$  (Revolutions per minute)

## Technical data

Contra-angles	WG-99 LT/A	WG-56 LT/A	WG-66 LT/A
Transmission ratio	1:5	1:1	2:1
Colour coding	1 orange ring	1 blue ring	1 green ring
Motor coupling	ISO 3964	ISO 3964	ISO 3964
Instrument acc. to EN ISO 1797-1:1995 ( $\emptyset$ mm)	1.6	2.35	2.5
Length in mm approved by W&H (mm)	25 *	34 *	34 *
Min. chuck length	until back stop	engaging	engaging
Max. operating part diameter (mm)	2,5	–	–
Max. motor speed ( $\text{min}^{-1}$ )	40,000	40,000	40,000
Spray flow rate acc. to ISO 7785-2 (ml/min)	> 50	> 50	> 50
Water setting range (rec. water pressure) (bar)	0.5 – 2 (1.5) **	0.5 – 2 (1.5) **	0.5 – 2 (1.5) *
Chip air setting range (must be higher than the water pressure) (rec. chip air pressure) (bar)	1.5 – 3 (2)**	1.5 – 3 (2)**	1.5 – 3 (2)**
Chip air consumption at 2 bar (l/min)	> 1.5	> 1.5	> 1.5

\* When using longer rotary instruments (or if the rotary instrument is not inserted up to the limit stop), the user must ensure by correct selection of the operating conditions, that there is no danger to the user, patient or third parties.

\*\* The chip air / water pressure must be set at the same time  
rpm =  $\text{min}^{-1}$  (Revolutions per minute)



## **Temperature information**

Temperature of the straight/contra-angle handpiece at the operator side: max. 55 °C (131 °F)

Temperature of the straight/contra-angle handpiece at the patient side: max. 50 °C (122 °F)

Temperature of the working part (rotary instrument): max. 41 °C (105.8 °F)

## **Physical characteristics**

Temperature for storage and transport: -40 °C to +70 °C

Air humidity for storage and transport: 8 % to 80 % (relativ), non-condensing

Ambient temperature during operation: +10 °C to +40 °C

Air humidity during operation: 15 % to 80 % (relativ), non-condensing

## 8. Recycling and disposal

---

### Recycling

W&H considers that it has a special duty towards the environment. The straight/contra-angle handpiece along with its packaging has been designed to be as environmentally friendly as possible.



### Disposal of the straight/contra-angle handpiece

Follow your country-specific laws, directives, standards and guidelines.

Ensure that the parts are not contaminated on disposal.

### Disposal of the packaging material

All packaging materials have been selected according to environmentally compatible and disposal aspects and can be recycled. Please send old packaging materials to the relevant collection and reprocessing system. This way, you will contribute to the recycling of raw materials and the avoidance of waste.

# Explanation of warranty terms

This W&H product has been manufactured with great care by highly qualified specialists. A wide variety of tests and controls guarantee faultless operation. Please note that claims under warranty can only be validated when all the directions in the instructions for use have been followed.

**As manufacturer, W&H is liable for material or manufacturing defects within a warranty period of 24 months from the date of purchase.**

We accept no responsibility for damage caused by incorrect handling or by repairs carried out by third parties not authorized to do so by W&H!

Claims under warranty – accompanied by proof of purchase – must be sent to the vendor or to an authorized W&H service partner. The provision of service under warranty extends neither the warranty period nor any other guarantee period.

**24 months warranty**



## **Authorized W&H service partner**

---

Find you nearest W&H service partner at <http://wh.com>

Simply go to the menu option »Service« for full details. Alternatively please contact:

**W&H (UK) LIMITED**, 6 Stroud Wood Business Centre, Park Street, St Albans, Herts AL2 2NJ, United Kingdom  
t +44 1727 874990, f +44 1727 874628, E-Mail: [technical.uk@wh.com](mailto:technical.uk@wh.com)

**W&H Impex Inc.**, 6490 Hawthorne Drive, Windsor, Ontario, N8T 1J9, Canada  
t +1 800 2656277, +1 519 9446739, f + 1 519 9746121, E-Mail: [service.ca@wh.com](mailto:service.ca@wh.com)

**W&H Impex Inc.**, 14300 Henn Rd., Dearborn, MI 48126, USA  
t +1 800 2656277, +1 519 9446739, f + 1 519 9746121, E-Mail: [service.us@wh.com](mailto:service.us@wh.com)

**W&H DENTAL-MECHANIK (ASIA) PTE-LTD.**, 18 Boon Lay Way, #10-94 Tradehub 21, 609966 Singapore  
t + 65 63168370, f + 65 63168371, E-Mail: [service.sg@wh.com](mailto:service.sg@wh.com)

**A-DEC AUSTRALIA CO. INC.**, Unit 8, 5-9 Ricketty Street, Mascot NWS 2020, Australia  
t +61 2 83324000, f +61 2 83324099, E-Mail: [a-dec@a-dec.com.au](mailto:a-dec@a-dec.com.au)





**Manufacturer**

**W&H Dentalwerk Bürmoos GmbH**  
**Ignaz-Glaser-Straße 53, 5111 Bürmoos, Austria**

**t +43 6274 6236-0, f +43 6274 6236-55**  
**office@wh.com    wh.com**

**Form-Nr. 50744 AEN**  
**Rev. 000 / 03.09.2012**  
**Subject to alterations**